

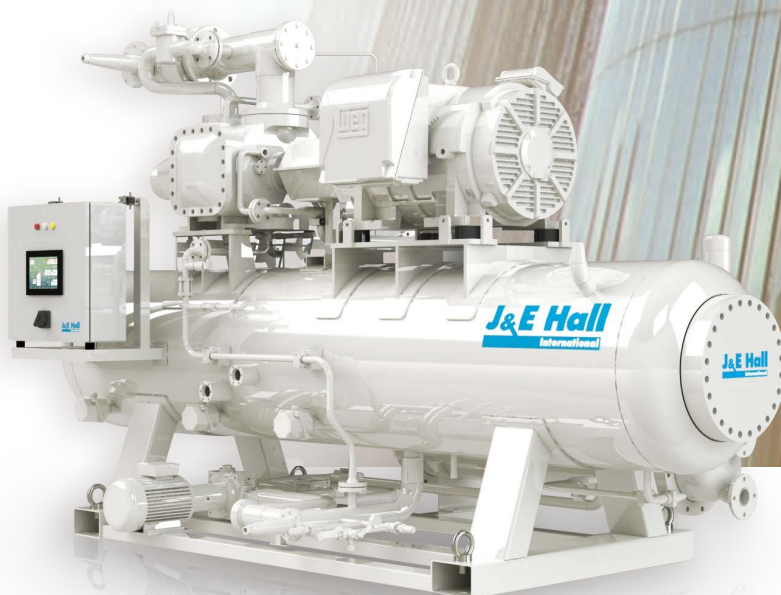

HallScrew Packs

COMPRESSOR PACK RANGE

Complete standard compressor package
using HallScrew single screw technology



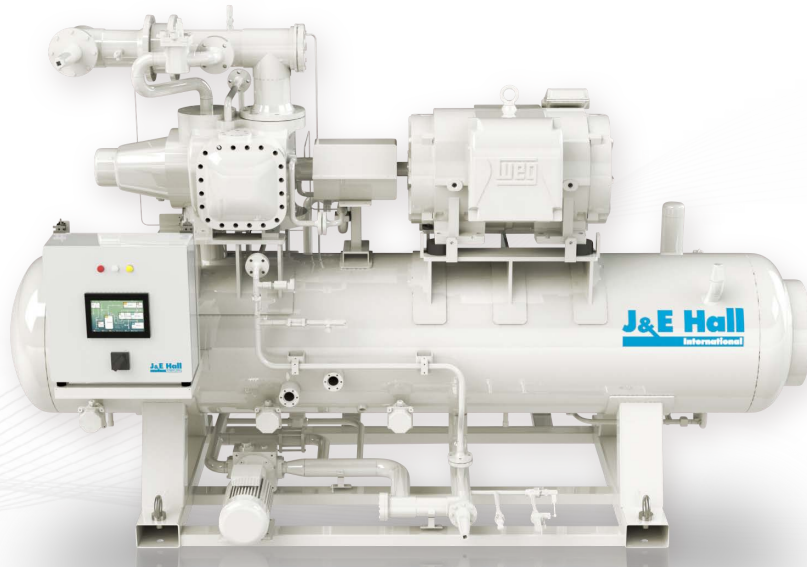

HallScrew standard compressor packs

J & E Hall supply the HallScrew compressor as a complete package with oil management system and controller for installing into refrigeration applications.

Single Screw Compressor Technology

High efficiency and outstanding reliability are key to the international success of the HallScrew single screw compressor. With only three basic moving parts, the compressors are extremely robust and boast a long main bearing life of 100,000 hours.

Our standard HallScrew compressors feature high efficiency slide valves to control capacity. Alternatively, we offer inverter technology which reduces power input to gain even higher efficiencies.

- ▶ Innovative screw compressor technology
- ▶ Outstanding reliability
- ▶ Superior efficiency
- ▶ Engineered for quiet operation
- ▶ Variable volume ratios
- ▶ Ease of installation and maintenance

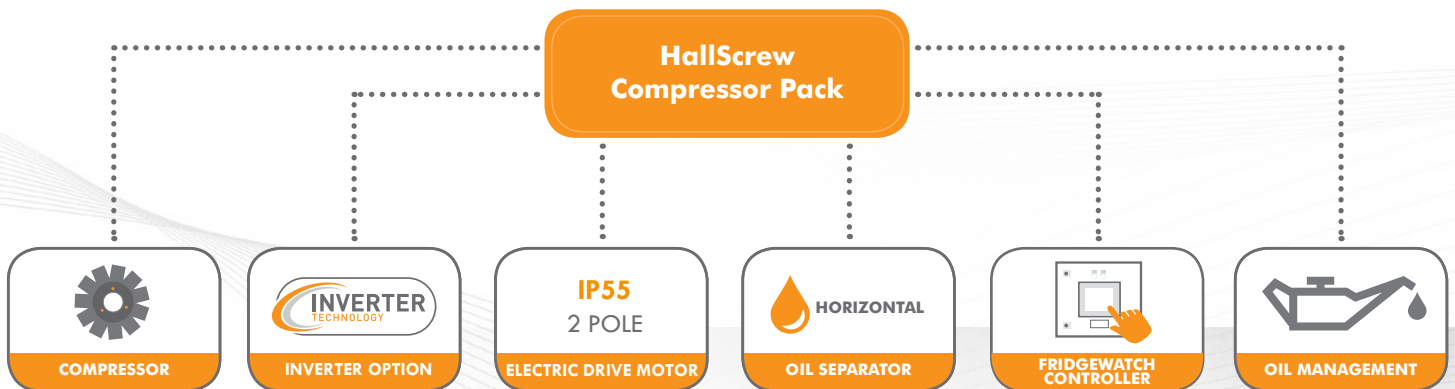

Compressor Pack Range

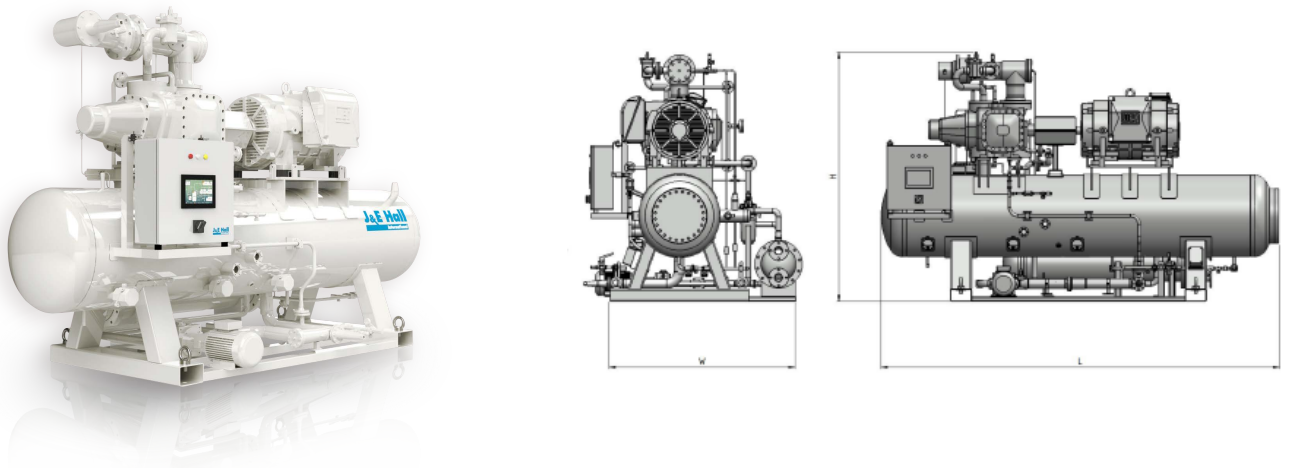

Displacement

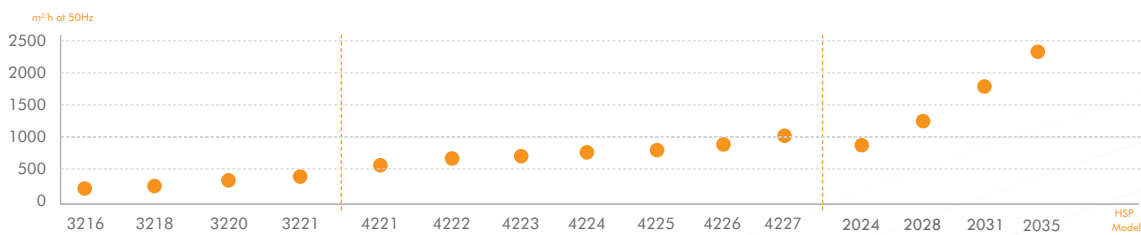

Applications

HallScrew compressor packs offer wide ranging cooling capacities for the most varied applications. Customers have the confidence in our compressor pack technology from deep freezing to standard refrigeration. Our packs are installed world-wide and used in a wide range of industries.

Standard Pack

Standard compressor packs comprise of the following:

- ▶ HallScrew single screw compressor
- ▶ IP55 2 pole electric drive motor
- ▶ Electronic controller
- ▶ Suction strainer and non return valve
- ▶ Oil separator
- ▶ Oil cooler or liquid injection kit
- ▶ Oil heater
- ▶ Oil management system (includes steel pipe work, oil filter, oil drain with non return valve)
- ▶ High pressure safety cut out (electro-mechanical)
- ▶ Oil pump as required
- ▶ Capacity control solenoid valves

Specifications

PLEASE NOTE: ALL WEIGHTS AND DIMENSIONS ARE FOR GUIDANCE ONLY AND WILL BE CONFIRMED UPON QUOTATION

HallScrew Pack	Displacement m ³ /h @	Maximum overall dimensions (mm)			Noise level dB(A)*	Suction Ø (mm)	Discharge Ø (mm)	Approx. dry weight with motor (kg)	Approx. oil charge (litres)
		Length	Width	Height		X	Y		
HSP 3216	286	2550	1500	2050	84	88	73	2510	160
HSP 3218	343	2550	1500	2050	84	88	73	2510	160
HSP 3220	415	2550	1500	2050	84	88	73	2510	160
HSP 3221	471	2550	1500	2050	84	88	73	2510	160
HSP 4221	504	3000	1600	1875	85	114	2 x 73	2510	170
HSP 4222	611	3000	1600	1875	86	114	2 x 73	2510	170
HSP 4223	716	3000	1600	1875	87	114	2 x 73	2510	170
HSP 4224	828	3000	1600	1875	87	114	2 x 73	2510	170
HSP 4225	898	3725*	1800*	2350*	88	141	114	4310*	235*
HSP 4226	980	3725*	1800*	2350*	89	141	114	4310*	235*
HSP 4227	1108	3725*	1800*	2350*	89	141	114	4310*	235*
HSP 2024	853	3345	1800	2070	92	141	114	3125	170
HSP 2028	1273	3725	1800	2350	89	168	141	4310	235
HSP 2031	1728	3725	1800	2500	92	219	168	4850	380
HSP 2035	2486	4600	1800	3070	92	219	168	6450	540

* TO BE CONFIRMED

Performance Data R717

OTHER REFRIGERANTS AVAILABLE ON REQUEST

HallScrew Pack	R717 COOLING CAPACITY (kW) SEE NOTE 1						
	-40	-30	-20	-10	0	10	
HSP 3216	43	77	126	182	273	392	
HSP 3218	53	95	154	222	334	481	
HSP 3220	65	117	198	275	412	593	
HSP 3221	74	133	217	312	467	673	
HSP 4221	81	145	238	345	420	751	
HSP 4222	98	176	288	419	630	911	
HSP 4223	115	207	338	490	739	1067	
HSP 4224	133	240	390	567	854	1234	
HSP 4225	168	288	453	635	947	1362	
HSP 4226	184	314	494	693	1033	1486	
HSP 4227	208	356	559	783	1146	1681	
HSP 2024	135	237	388	561	849	1234	
HSP 2028	207	258	581	838	1266	1839	
HSP 2031	288	497	805	1157	1744	2529	
HSP 2035	435	736	1176	1679	2521	3646	

NOTE 1: Performance data tables: External oil cooling, discharge gauge 35°C, liquid subcooling 5°C, suction superheat 5°C
Suction and discharge gauge conditions refer to inlet and outlet flange of the compressor.

Economised 

Allowance for pressure drop upstream and downstream of the compressor must be made. * Contact your local representative for details

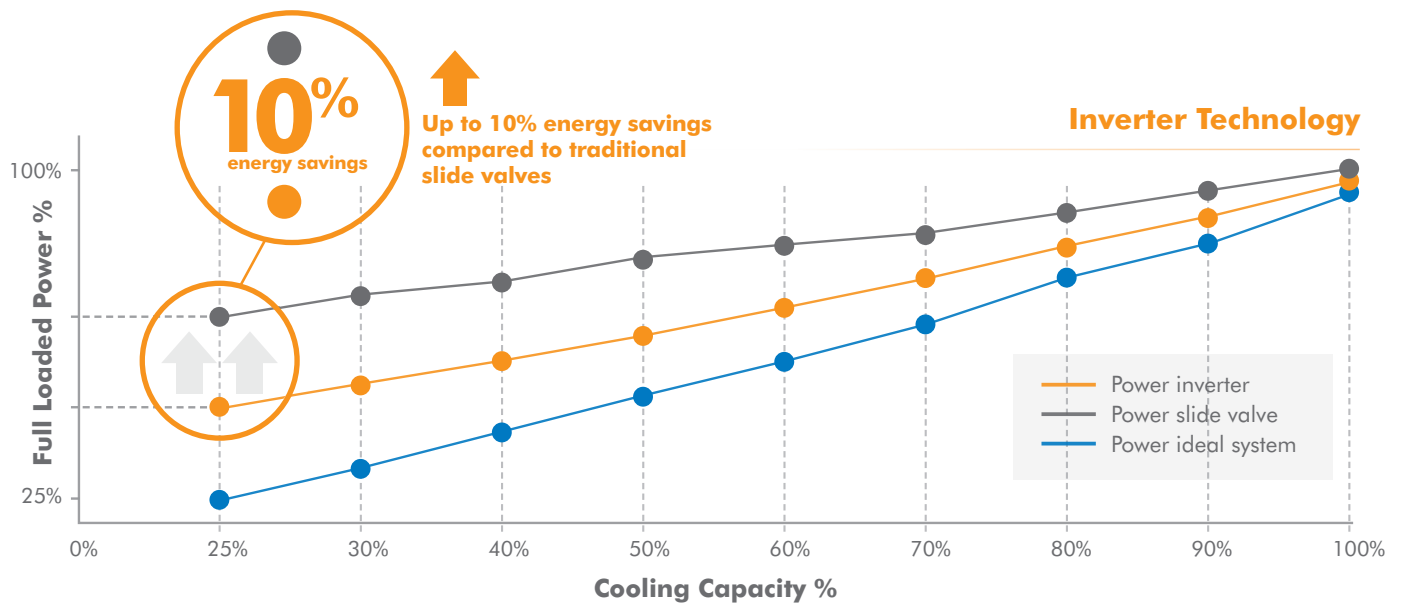

Hansard Gate, West Meadows, Derby, DE21 6JN

T: 01332 253400 E: marketing@jehall.co.uk

@jehallfridge

www.jehall.com

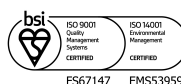

HSP_40_0124